

VDD_BUFF = 2.8V REQUIRES R6041, R6042, C6039
 VDD_BUFF = 1.8V CONNECT D6030 PIN4 DIRECT TO N6030 XTAL_IN (K3)

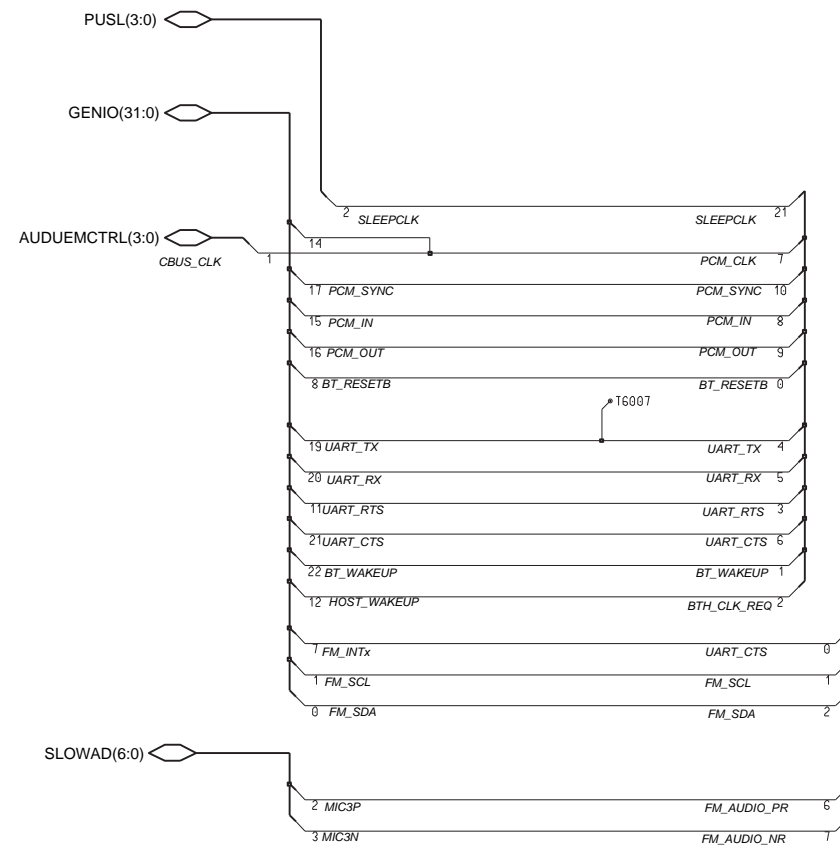

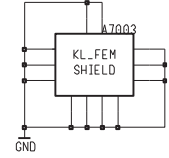

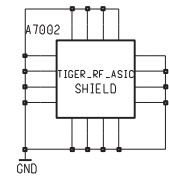

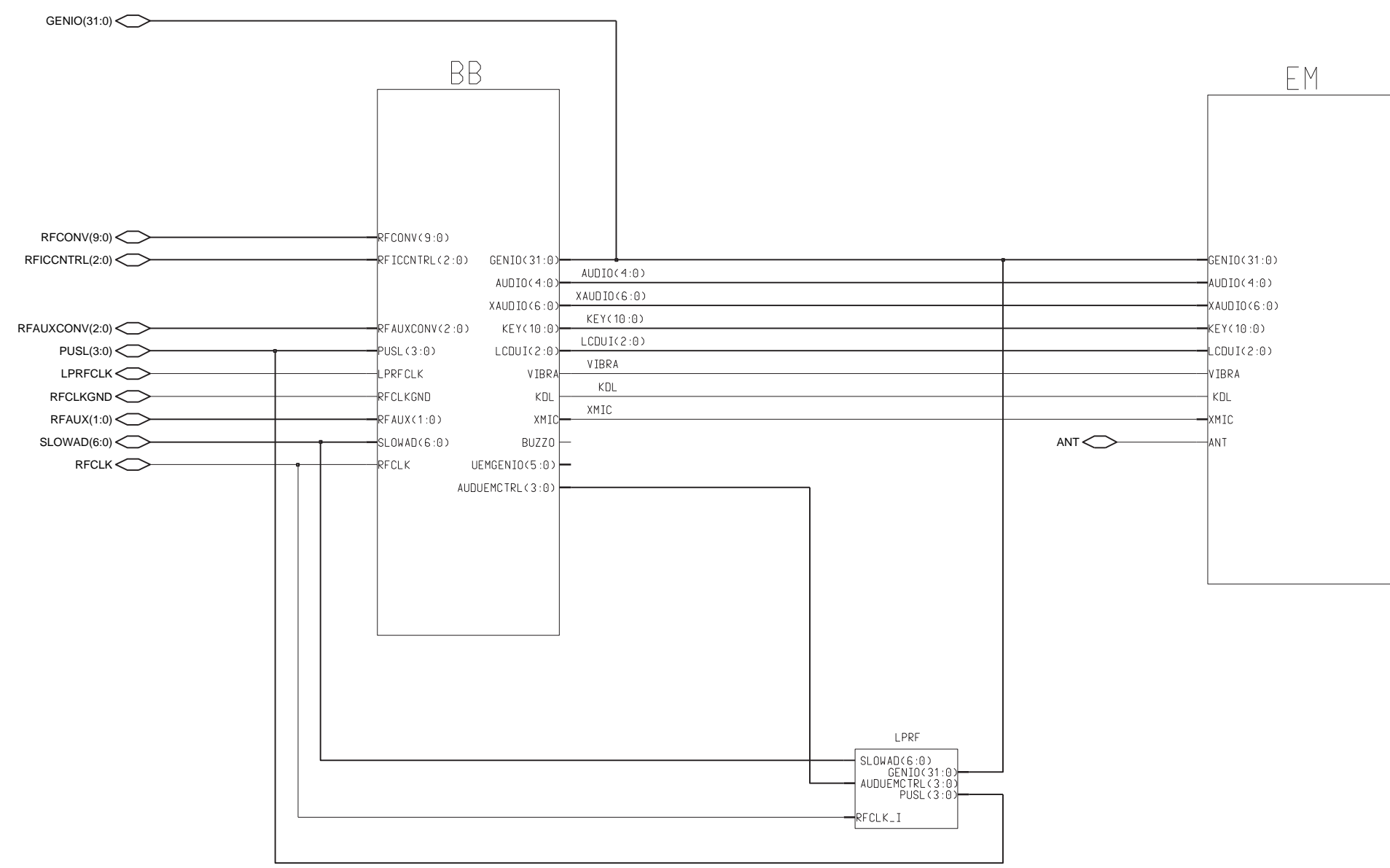
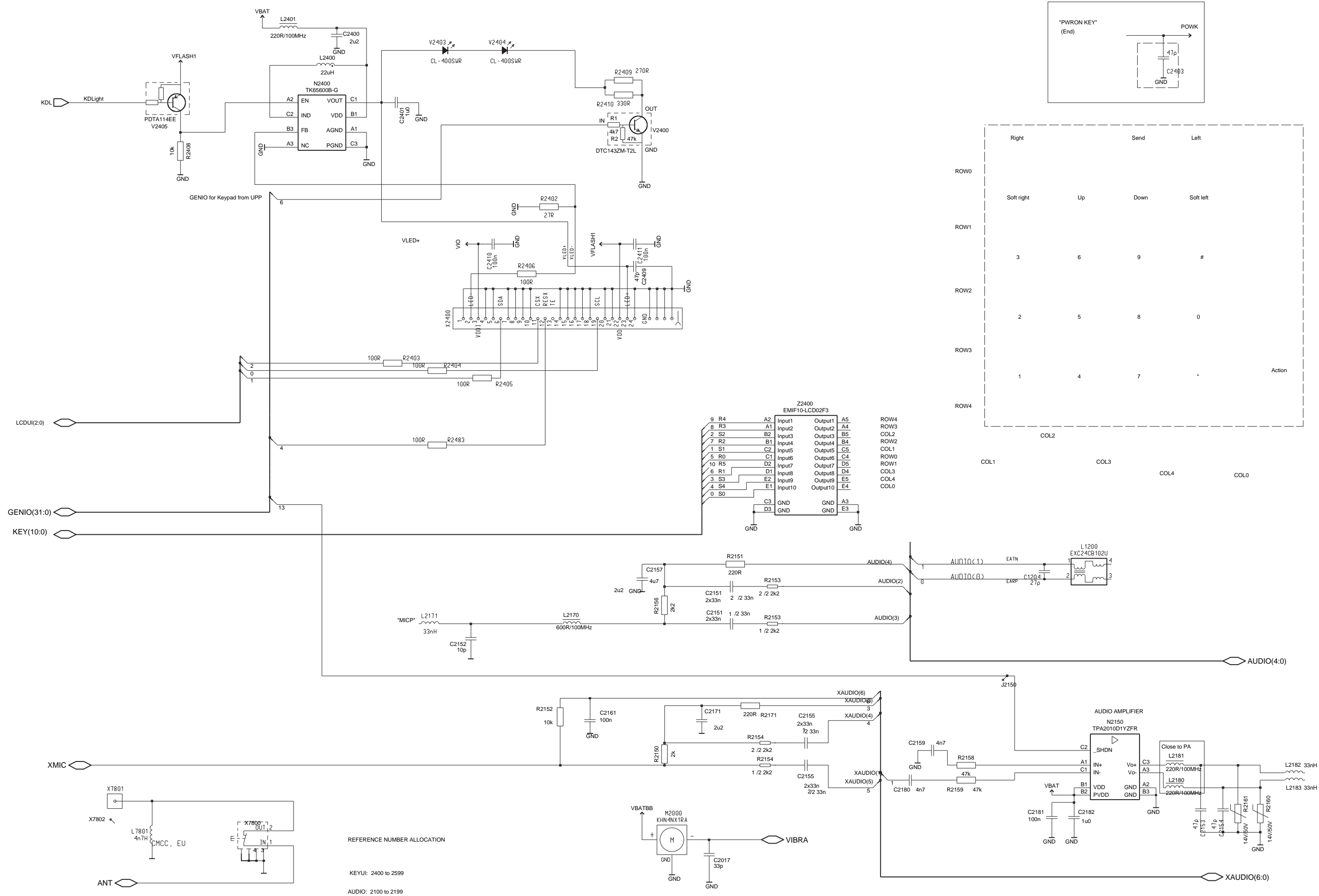

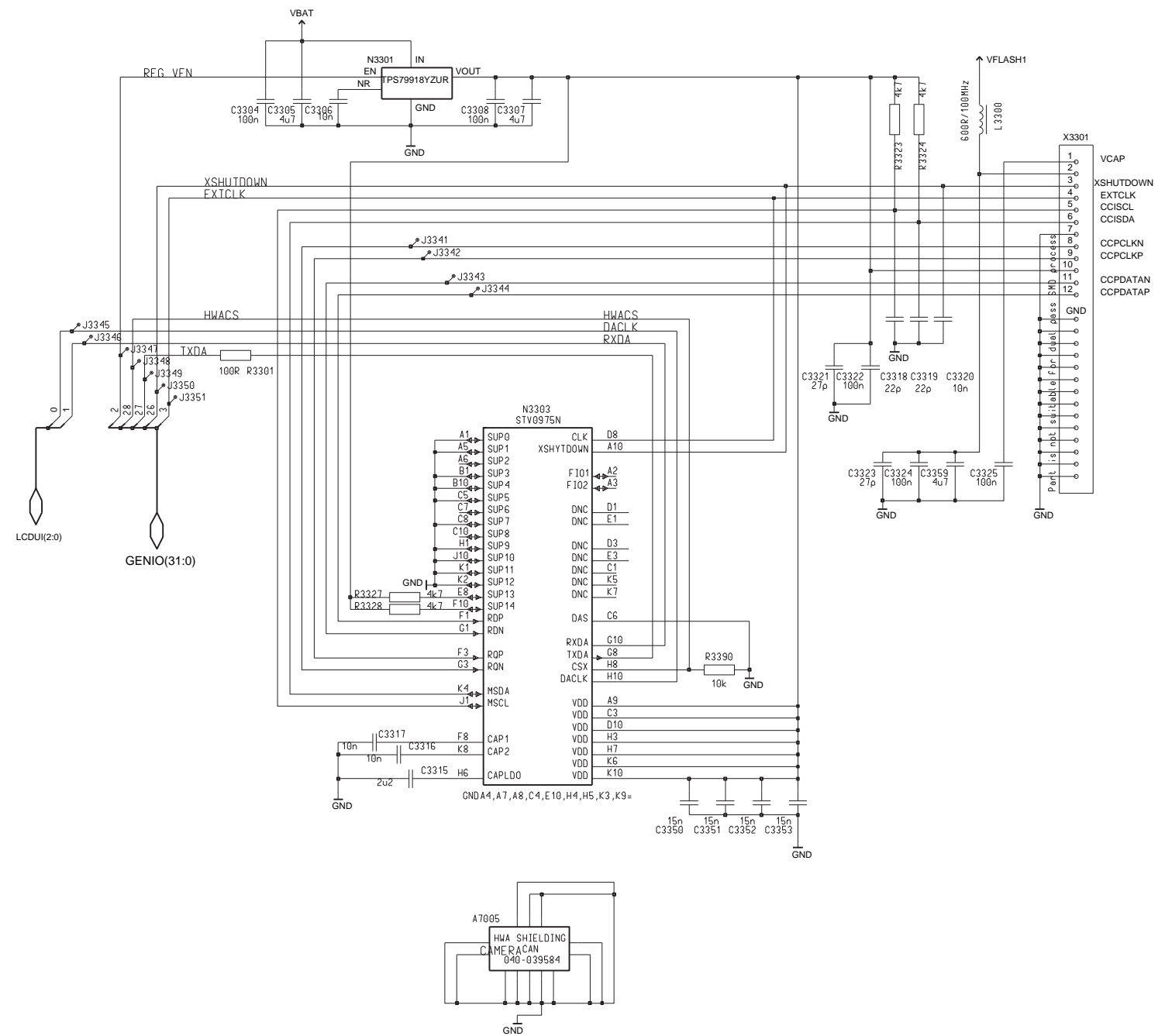

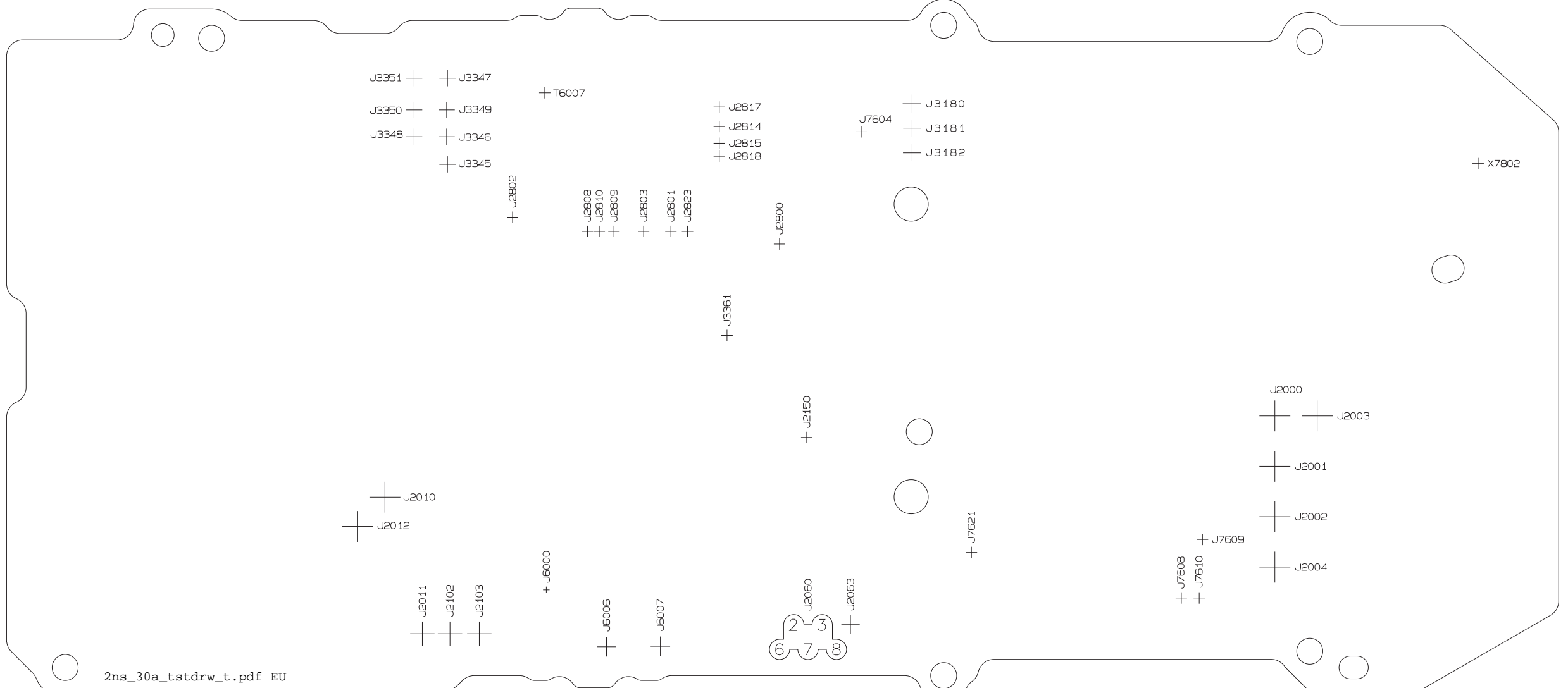

2ns_30a_tstdrw_t.pdf EU

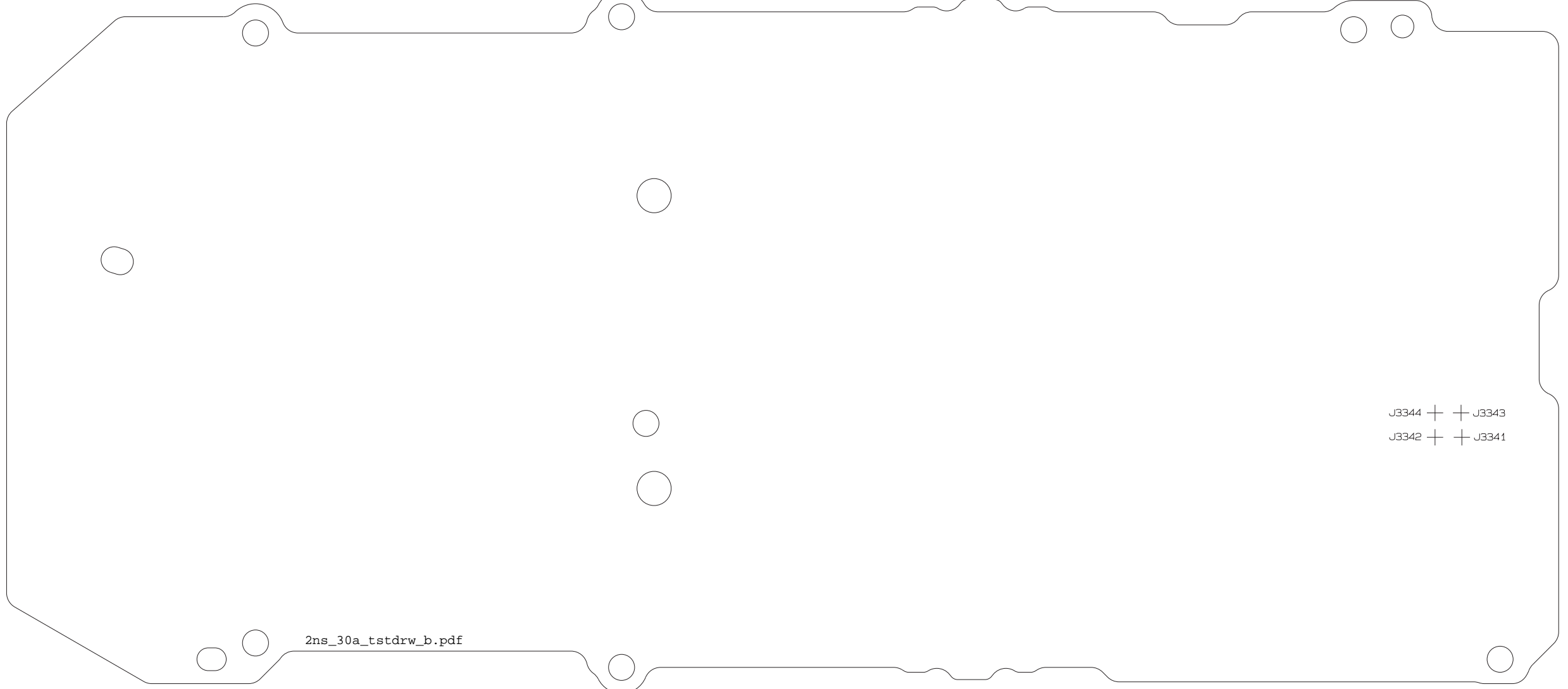

2ns_30a_tstdrw_b.pdf

